

**THE SHADE STORE MOTORIZATION**

# Remote Programming Guide

**BY: THE SHADE STORE**

# SAFETY INSTRUCTIONS & COMPLIANCE SHEET

## WARNING: Important safety instructions to be read before installation and use.

Incorrect installation or use can lead to serious injury and will void manufacturer's liability and warranty.

It is important for the safety of persons to follow the enclosed instructions. Save these instructions for future reference.

- Do not expose to water, moisture, humid and damp environments or extreme temperatures.
- Persons (including children) with reduced physical, sensory or mental capabilities, or lack of experience and knowledge should not be allowed to use this product.
- Use or modification outside the scope of this instruction manual will void warranty.
- Installation and programming to be performed by a suitably qualified installer.
- Follow installation instructions.
- For use with motorized shading devices.
- Keep away from children.
- Frequently inspect for improper operation. Do not use if repair or adjustment is necessary.
- Keep clear when in operation.
- Replace battery with correctly specified type.

The Shade Store declares this equipment is in compliance with the essential requirements and other relevant provisions of R&TT EC Directive 1999/5/EC

## Statement Regarding FCC / IC Compliance

This device complies with Part 15 of the FCC Rules / Industry Canada licence-exempt RSS standard(s). Operation is subject to the following two conditions:

1. this device may not cause harmful interference, and
2. this device must accept any interference received, including interference that may cause undesired operation.

*Le présent appareil est conforme aux CNR d'Industrie Canada applicables aux appareils radio exempts de licence. L'exploitation est autorisée aux deux conditions suivantes : (1) l'appareil ne doit pas produire de brouillage, et (2) l'utilisateur de l'appareil doit accepter tout brouillage radioélectrique subi, même si le brouillage est susceptible d'en compromettre le fonctionnement.*

Changes or modifications not expressly approved by the party responsible for compliance could void the user's authority to operate the equipment.

This equipment has been tested and found to comply with the limits for a Class B digital device, pursuant to part 15 of the FCC rules. These limits are designed to provide reasonable protection against harmful interference in a residential installation. This equipment generates, uses and can radiate radio frequency energy and, if not installed and used in accordance with the instructions, may cause harmful interference to radio communications. However, there is no guarantee that interference will not occur in a particular installation. If this equipment does cause harmful interference to radio or television reception, which can be determined by turning the equipment off and on, the user is encouraged to try to correct the interference by one or more of the following measures:

- Reorient or relocate the receiving antenna
- Increase the separation between the equipment and receiver
- Connect the equipment into an outlet on a circuit different from that to which the receiver is connected
- Consult the dealer or an experienced radio/TV technician for help



Do not dispose of in general waste.

Please recycle batteries and damaged electrical products appropriately.



# Table of Contents

Each battery & plug-in motor from The Shade Store will come preprogrammed from the factory. The preprogramming ensures the remote is paired with the motor, the upper and lower operation limits are set, the remote is locked and the unnecessary channels are hidden for ease of use (15 available).

1. Remote Overview
2. Sleep Mode
3. Adjusting Limits
4. Favorite Positions
5. Remote & Motor Pairing
6. Mirroring Remotes
7. Group Control
8. Hiding/Unhiding Remote Channels
9. Adjusting Motor Speed
10. Reset to Factory Settings
11. Initial Setup Programming
12. Reverse Motor Direction
13. Tilt Mode
14. Troubleshooting

# Remote Overview

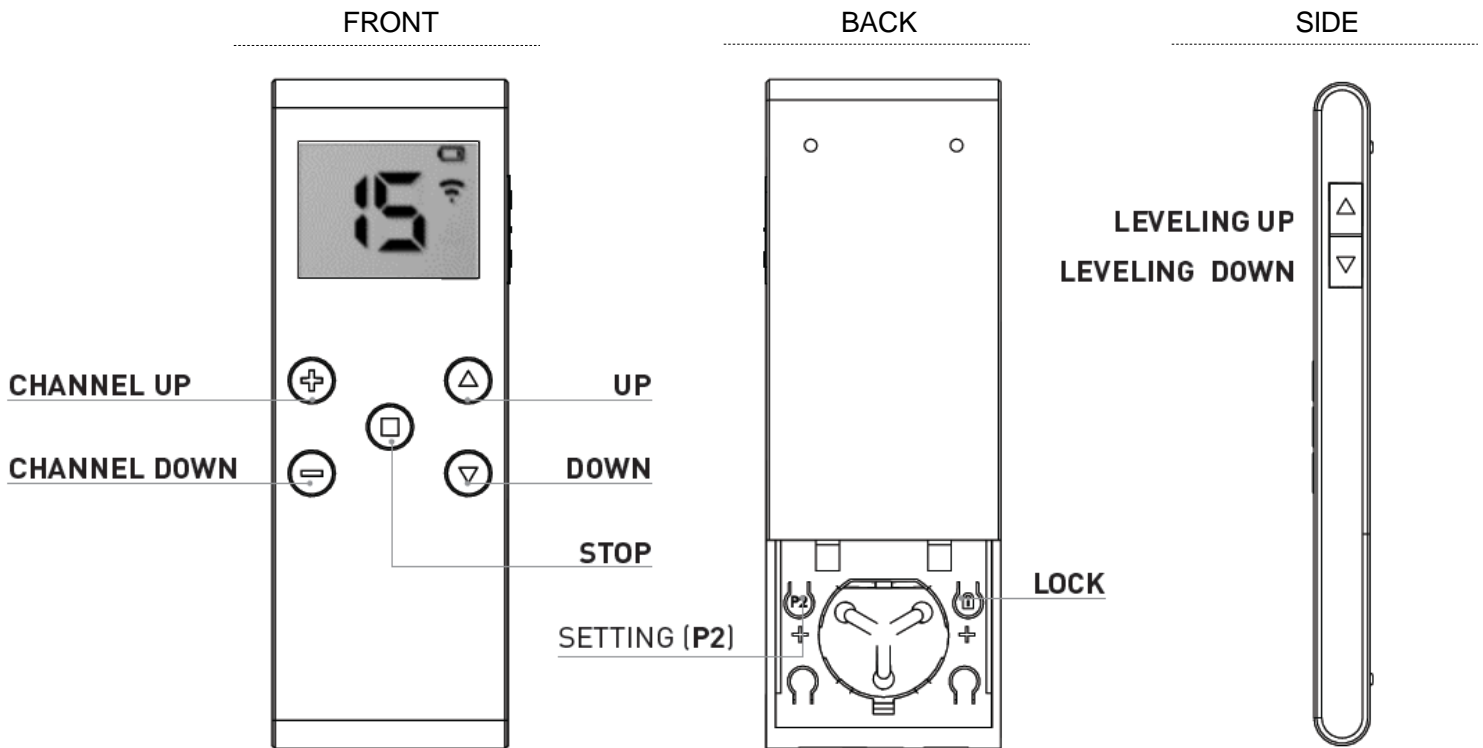

TECHNICAL SPECIFICATIONS	
Voltage:	3V (CR2450)
Frequency:	433.92 MHz
Transmitting Power:	10 milliwatt
Ambient Operating Temperature:	-10°C - 50°C
Transmission Distance:	Approx. 65 feet in open space
Battery:	CR2450

## FEATURES

- Push Button controls
- Levelling control
- LCD Display
- Hide unused channels function
- Slim magnetic wall mount holder

## PACKAGE CONTENTS

- Remote
- Magnetic wall mount holder & fixing screws
- One 3V - CR2450 Battery

## INSTALL WALL MOUNT HOLDER

Remove cover from base by prying with flat head screwdriver.

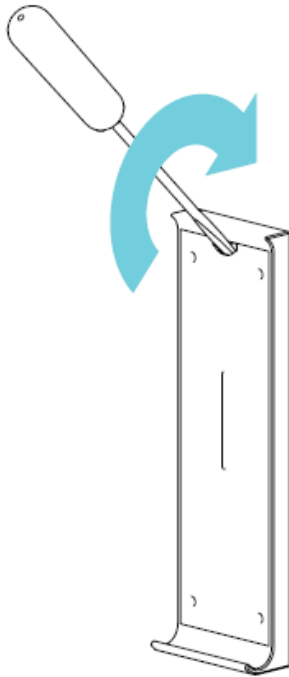

Use supplied fasteners and anchors to attach the base to the wall.

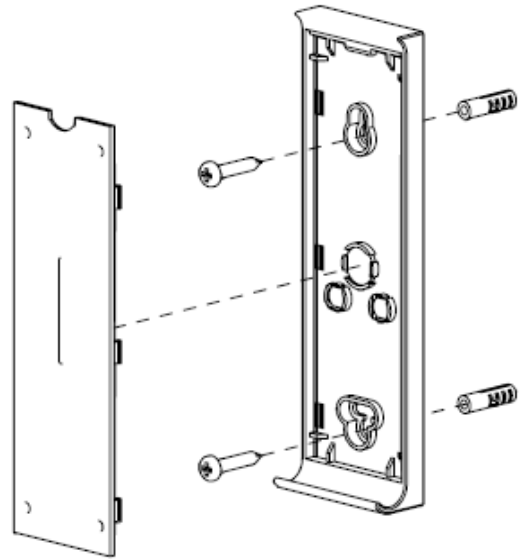

## INSTALL AND/OR REPLACE REMOTE BATTERY

Remove cover from remote press gently in and down to disengage cover.

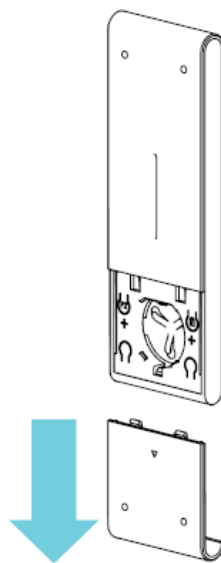

Slide to remove

Install battery with positive (+) side facing up.

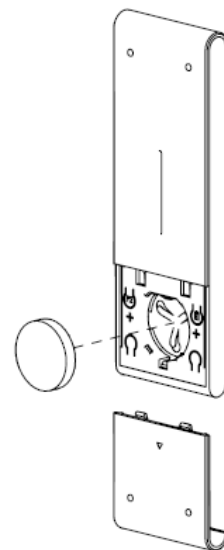

Snap covers back together.

# Sleep Mode

Each battery & plug-in motor will come preprogrammed from The Shade Store. Upon leaving the factory the motor is placed into “Sleep Mode” to avoid accidental operation during shipping. It is necessary to “Wake” the motor before operation and setup.

*(Applicable to tubular internal battery motors and drapery motor only. Motors with an external battery do not have Sleep Mode.)*

## Exit Sleep Mode

To “Wake” the motor and exit Sleep Mode, assure the motor is installed and secured in the mounting hardware.

Once installed safely and securely, press and hold the programming button on the motor head until the motor jogs once. For a drapery motor, you can also TUG on the drapery (if attached) to activate the motor. It is now no longer in “Sleep Mode” and ready for further setup.

### **Warning:**

- *Shade - if you press and release the programming button quickly, the motor will operate to its limit.*
- *Drapery – The drapery will operate to the full extent of the track.*



## Enter Sleep Mode

If required, to place the motor back into “Sleep Mode” press and hold the programming button for a period of 6 seconds. Release the button when the motor has jogged **twice**. The motor will beep twice to signify “Sleep Mode” has been activated.

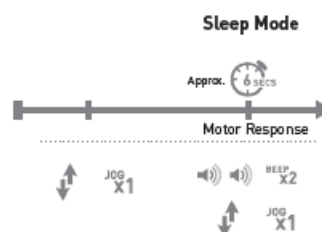
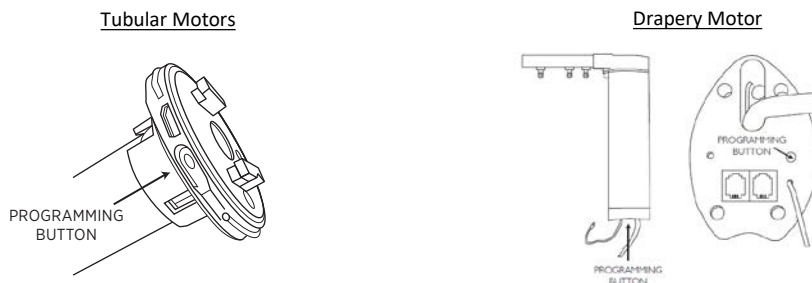

**Note: Drapery motor will only beep.**

# Adjusting Limits

Each battery & plug-in motor will come preprogrammed from The Shade Store. The preprogramming ensures the remote is paired with the motor, the upper and lower operation limits are set, the remote is locked and the unnecessary channels are hidden for ease of use (15 available).

Follow the below steps to adjust the upper and lower limits if required.

If limits need adjusting, follow the instructions below to unlock the remote for limit setting:

- Unlock the limit setting functionality by pressing the top right button on the back of the remote (remove cover to expose the button)
- Press and hold the button for approximately 8 seconds until the LED display shows a flashing "U", then release.
- PLEASE NOTE - You will need to "Lock" the remote once final adjustments have been made. Simply repeat the above step until a flashing "L" shows on the display ("U" for unlocked, "L" for locked).

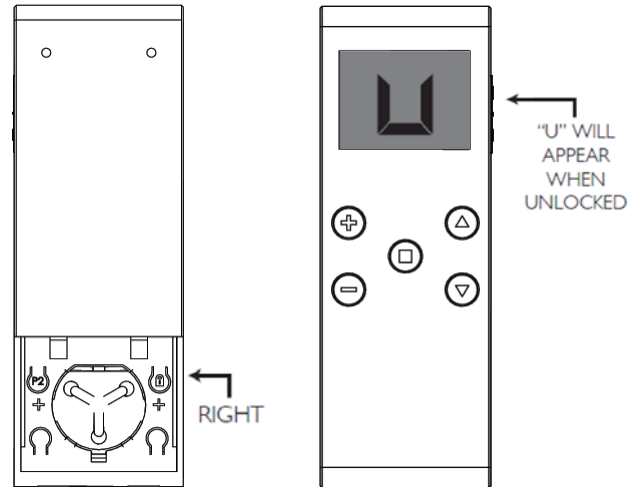

## ADJUSTING UPPER LIMIT

### (DELETE Top Limit)

Press UP & STOP (5sec)

Motor Response

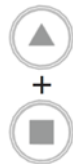

Move the shade to the new desired position to be set as limit.

**Important!!** Stop the shade prior to traveling past the desired upper limit

### (SET Top Limit)

Press UP + STOP (5sec)

Motor Response



Note: Drapery motor will only beep.

## ADJUSTING LOWER LIMIT

### (DELETE Lower Limit)

Press DOWN & STOP (5sec)

Motor Response

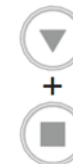

Move the shade to the new desired position to be set as limit.

**Important!!** Stop the shade prior to traveling past the desired lower limit

### (SET Lower Limit)

Press DOWN + STOP (5sec)

Motor Response



Note: Drapery motor will only beep.

**!!WARNING!!** - Move shade in short increments by pressing the UP/DOWN button in 1 second intervals (pressing the UP/DOWN button for more than 3 seconds may send the shade past desired upper/lower limit and may result in damage to the product). Once you have reached the desired upper/lower limit, you can adjust the limit with either the UP and DOWN buttons. (remember to adjust in short increments!)







# Favorite Positions

Each battery & plug-in motor will come preprogrammed from The Shade Store. The preprogramming ensures the remote is paired with the motor, the upper and lower operation limits are set, the remote is locked and the unnecessary channels are hidden for ease of use (15 available).

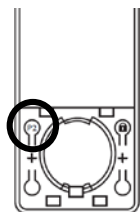
Follow the below steps to set a favorite position. The favorite position is used to set a custom stopping point between the upper and lower limits. (1 favorite position per shade motor)







To set a favorite position for a shade motor, drive to the desired position and press the STOP button to pause the drive operation.

## SETTING FAVORITE POSITION

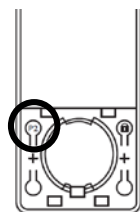
<p><b>1 (To Save Position)</b></p> <p>Press <b>UP</b> or <b>DOWN</b> to move shade to desired favorite position</p>	<p><b>2</b> Press left <b>P2</b> (1sec)</p> 	<p><b>3</b> Press <b>STOP</b> (1sec)</p> 	<p><b>4</b> Press <b>STOP</b> (1sec)</p> 
<p>Motor Response</p> <p>.....</p> 	<p>Motor Response</p> <p>.....</p> 	<p>Motor Response</p> <p>.....</p> 	
<p>Note: Drapery motor will only beep.</p>	<p>Note: Drapery motor will only beep.</p>	<p>Note: Drapery motor will only beep.</p>	

- Press **STOP** (3sec) to move shade to the Favorite Position from any location
- Repeat Steps 1-4 for all additional motors

## DELETING FAVORITE POSITION

<p><b>1 (To Delete Position)</b></p> <p>Press <b>STOP</b> (3 sec) to send the shade to the stored favorite position.</p>	<p><b>2</b> Press left <b>P2</b> (1sec)</p> 	<p><b>3</b> Press <b>STOP</b> (1sec)</p> 	<p><b>4</b> Press <b>STOP</b> (1sec)</p> 
<p>Motor Response</p> <p>.....</p> 	<p>Motor Response</p> <p>.....</p> 	<p>Motor Response</p> <p>.....</p> 	
<p>Note: Drapery motor will only beep.</p>	<p>Note: Drapery motor will only beep.</p>	<p>Note: Drapery motor will only beep.</p>	





# Remote + Motor Pairing

Each battery & plug-in motor will come preprogrammed from The Shade Store. The preprogramming ensures the remote is paired with the motor, the upper and lower operation limits are set, the remote is locked and the unnecessary channels are hidden for ease of use (15 available).

Follow the below steps to select the remote channel you want to pair with the motor(s) if required at a later date.

## 1. SELECT CHANNEL

<p><b>1a</b></p> <p>Press any button to wake remote.</p>	<p><b>1b</b></p> <p>Within <b>10sec</b> Press <b>UP or DOWN</b> to select desired channel.</p>	 or 	<p><b>1c</b></p> <p>Press <b>STOP</b> to confirm selection OR remote will auto confirm after 4sec.</p>	
--	--	--	--	---

## 2. PAIRING REMOTE TO MOTOR

**2a** ACTIVATE PAIRING MODE ON MOTOR

Press & HOLD Programming Button on motor head (2sec)

Tubular Motors

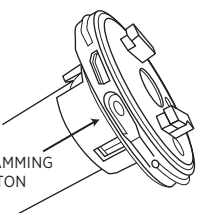

Drapery Motor

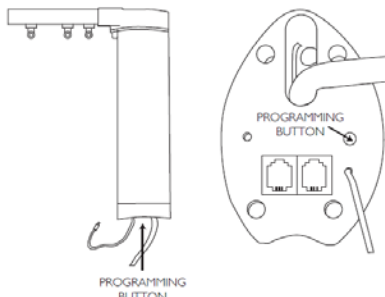

Motor Response



*Note: Drapery motor will only beep.*

Cellular Battery Motor

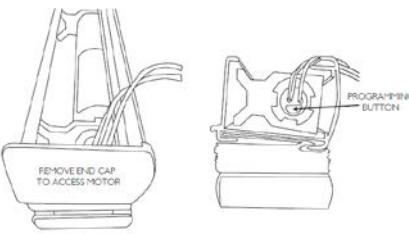

Wood Blind Tilt Motor

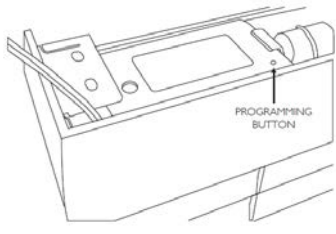

---

**2b** PAIRING REMOTE

Within 4 sec of activating pairing mode, Press & Hold **STOP**



Motor Response



*Note: Drapery motor will only beep.*



If you do not pair the remote in time the motor pairing sequence will time out, repeat the above steps assuring to press and hold the STOP button within 4 seconds of the motor jog

# Mirroring Remotes

Each battery & plug-in motor will come preprogrammed from The Shade Store. The preprogramming ensures the remote is paired with the motor, the upper and lower operation limits are set, the remote is locked and the unnecessary channels are hidden for ease of use (15 available).









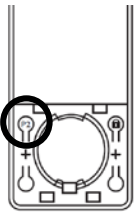
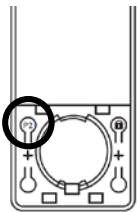
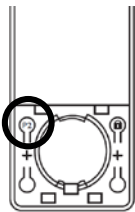

Follow the below steps to copy settings from an existing remote to a new remote.

## 1. SELECT CHANNEL

<p><b>1a</b></p> <p>Press any button to wake remote.</p>	<p><b>1b</b></p> <p>Within <b>10sec</b> Press <b>UP or DOWN</b> to select desired channel.</p>	 <p>+</p> <p>or</p> <p>-</p>	<p><b>1c</b></p> <p>Press <b>STOP</b> to confirm selection OR remote will auto confirm after 4sec.</p>	
--	--	---	--	---

Note: Select channel on existing remote to be copied  
 Select channel on new remote where existing channel will be copied

## 2. ADD OR REMOVE REMOTE USING AN EXISTING REMOTE

<p><b>1</b> Press left P2 (1sec)</p>  <p>EXISTING</p>	<p><b>2</b> Press left P2 (1sec)</p>  <p>EXISTING</p>	<p><b>3</b> Press left P2 (1sec)</p>  <p>NEW (To be Added or Removed)</p>
<p>Motor Response</p> <p> BEEP X1</p> <p> JOG X1</p>	<p>Motor Response</p> <p> BEEP X1</p> <p> JOG X1</p>	<p>Motor Response</p> <p>   BEEP X3</p> <p>  JOG X2</p>
<p>Note: Drapery motor will only beep.</p>	<p>Note: Drapery motor will only beep.</p>	<p>Note: Drapery motor will only beep.</p>



# Group Control

Each battery & plug-in motor will come preprogrammed from The Shade Store. If multiple motors are paired to the same 15 channel remote, the 0 channel is the default channel to control all motors at once.

Follow the steps below to group motors on a specific channel for simultaneous control.

To custom define a channel to control multiple motors, pairing in groups can be executed. This will allow you to operate a series of motors in unison without needing to change channels. Each motor to be grouped must be paired with the remote on its own channel prior to grouping.

## 1. SELECT CHANNEL TO BE PAIRED AS A GROUP

<p><b>1a</b></p> <div style="border: 1px dashed black; padding: 5px; margin: 5px auto; width: 80%;"> <p>Press any button to wake remote.</p> </div>	<p><b>1b</b></p> <div style="border: 1px dashed black; padding: 5px; margin: 5px auto; width: 80%;"> <p>Within <b>10sec</b> Press <b>UP</b> or <b>DOWN</b> to select desired channel.</p> </div>	 or 	<p><b>1c</b></p> <div style="border: 1px dashed black; padding: 5px; margin: 5px auto; width: 80%;"> <p>Press <b>STOP</b> to confirm selection OR remote will auto confirm after 4sec.</p> </div>
---	--	--	---

## 2. PAIRING OR REMOVING MOTOR FROM A SPECIFIC CHANNEL

### 2a ACTIVATE PAIRING MODE ON MOTOR

**Press & HOLD Programming Button on motor head (2sec)**

**Motor Response**



Note: Drapery motor will only beep.

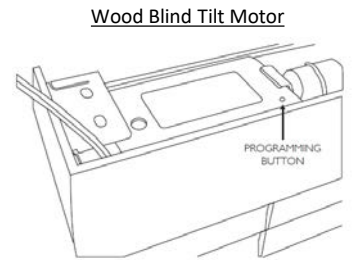
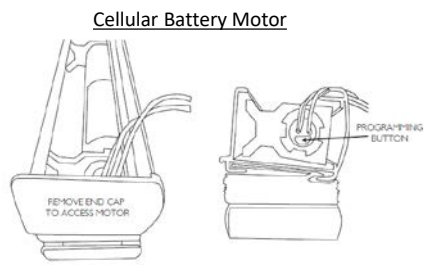
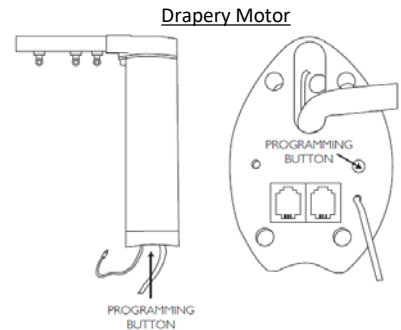
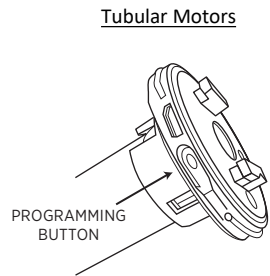

### 2b PAIRING REMOTE

**Within 4 sec of activating pairing mode, Press & Hold STOP**



**Motor Response**



Note: Drapery motor will only beep.

If you do not pair the remote in time the motor pairing sequence will time out, repeat the above steps assuring to press and hold the STOP button within 4 seconds of the motor jog

# Group Control

## 3. Adjusting limits of an individual shade paired on a group channel

To adjust the limits of a shade that is currently grouped on a channel with other shades, it is necessary to place all shades with the exception of the shade to be adjusted, to sleep.

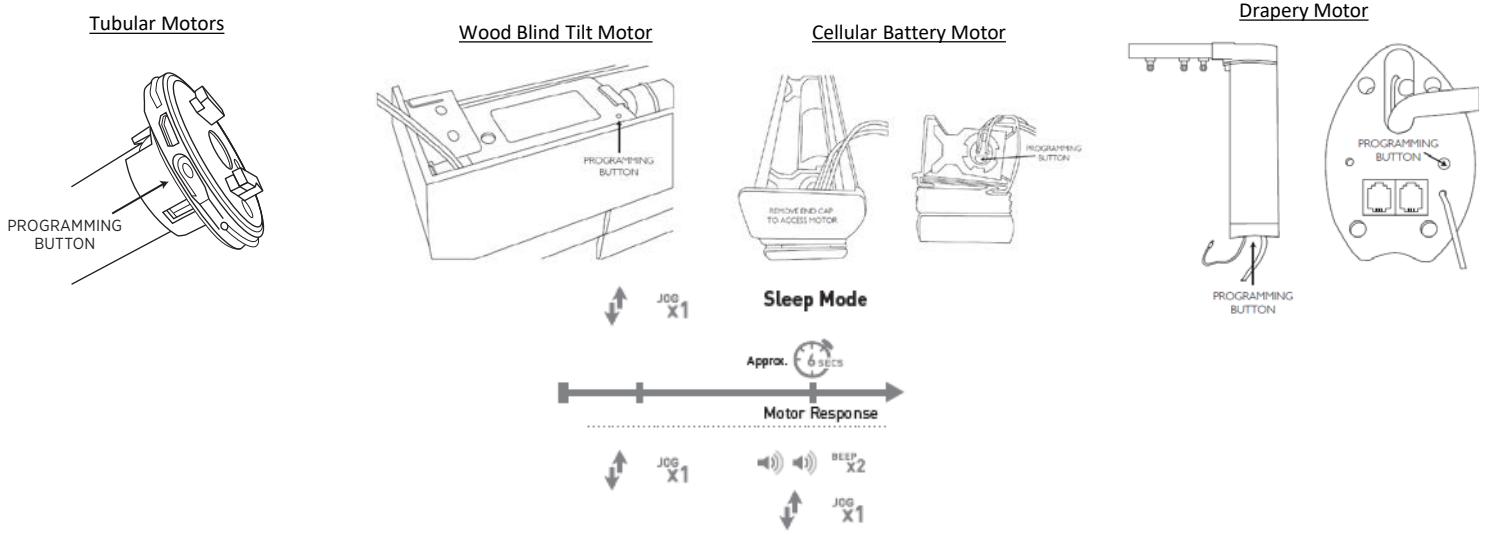

Once all other shades have been put to sleep, unlock remote by pressing and holding the upper left P2 button under the battery cover until "U" is displayed on the LCD screen. Adjust the shade limits as outlined below:

### ADJUSTING UPPER LIMIT

**(DELETE Top Limit)**

Press **UP & STOP (5sec)**

Motor Response

BEEP X1

JOG X1

Move the shade to the new desired position to be set as limit.

**Important!!** Stop the shade prior to traveling past the desired upper limit

*Note: Drapery motor will only beep.*

**(SET Top Limit)**

Press **UP + STOP (5sec)**

Motor Response

BEEP X3

JOG X2

### ADJUSTING LOWER LIMIT

**(DELETE Lower Limit)**

Press **DOWN & STOP (5sec)**

Motor Response

BEEP X1

JOG X1

Move the shade to the new desired position to be set as limit.

**Important!!** Stop the shade prior to traveling past the desired lower limit

*Note: Drapery motor will only beep.*

**(SET Lower Limit)**

Press **DOWN + STOP (5sec)**

Motor Response

BEEP X3

JOG X2

**!!WARNING!!** - Move shade in short increments by pressing the UP/DOWN button in 1 second intervals (pressing the UP/DOWN button for more than 3 seconds may send the shade past desired upper/lower limit and may result in damage to the product). Once you have reached the desired upper/lower limit, you can adjust the limit with either the UP and DOWN buttons. (remember to adjust in short increments!)

Once the limits have been adjusted as desired, return the remote control to "L" mode by pressing and holding the upper left P2 button under the battery cover. The other grouped motors can now be taken out of sleep mode by holding the programming button for 6 seconds

# Hide/Unhide Remote Channels

Each battery & plug-in motor will come preprogrammed from The Shade Store. The preprogramming ensures the remote is paired with the motor, the upper and lower operation limits are set, the remote is locked and the unnecessary channels are hidden for ease of use (15 available).

Follow the below steps to hide and unhide channels on the remote.

**1** Hold **CHANNEL UP** and **CHANNEL DOWN** for 5 seconds



Display Response



**2** Press **CHANNEL UP** or **CHANNEL DOWN** to select number of channels



**3** Press **STOP** for 2 seconds



Display Response

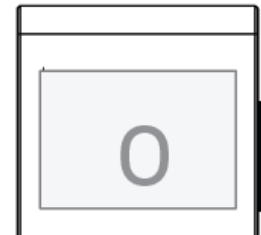

# Adjusting Motor Speed

(ONLY APPLICABLE TO BATTERY MOTORS and DRAPER Y MOTOR)

Each battery & plug-in motor will come preprogrammed from The Shade Store. The preprogramming ensures the remote is paired with the motor, the upper and lower operation limits are set, the remote is locked and the unnecessary channels are hidden for ease of use (15 available).

Follow the below steps to adjust the motor speed. To adjust the motor speed a remote must be paired.

To enter speed adjustment mode remove the rear battery cover of the remote. Press and hold the left P2 button for 2 seconds. The motor will perform one up and down jog and beep once.

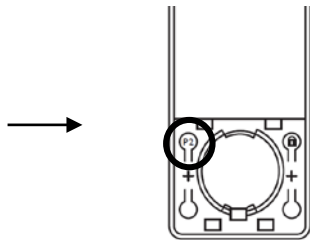
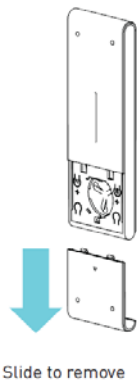

Motor Response



To Increase speed:

Press **UP**.



Motor Response



Note: Drapery motor will only beep.

Repeat

Press **UP**.



Motor Response



Note: Drapery motor will only beep.



**IMPORTANT**

If motor does not react to speed adjustment, the maximum or minimum speed has already been reached.

To Decrease speed:

Press **DOWN**.



Motor Response



Note: Drapery motor will only beep.

Repeat

Press **DOWN**.



Motor Response



Note: Drapery motor will only beep.



**IMPORTANT**

If motor does not react to speed adjustment, the maximum or minimum speed has already been reached.

# Reset to Factory Settings

Each battery & plug-in motor will come preprogrammed from The Shade Store. The preprogramming ensures the remote is paired with the motor, the upper and lower operation limits are set, the remote is locked and the unnecessary channels are hidden for ease of use (15 available).

Follow the below steps to reset the motor to factory settings and delete all limits/remote pairings.

To reset the shade motor to factory settings with no stored limits locate the P1 button on the motor head. Hold the programming button for 14 seconds. (4 motor jogs)  
*(\*\*External battery motors will jog 3 times for a full factory reset\*\*)*

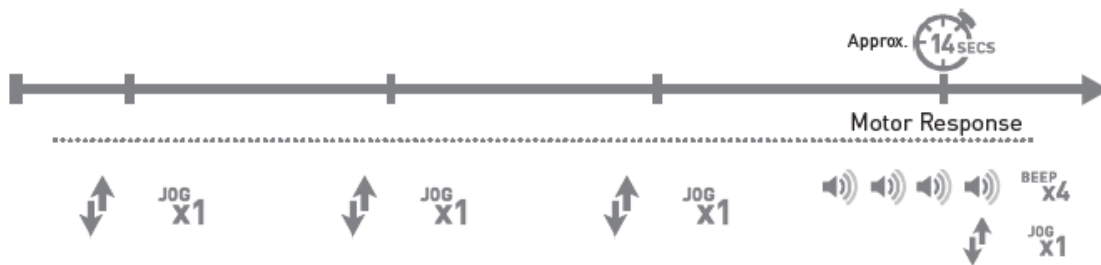
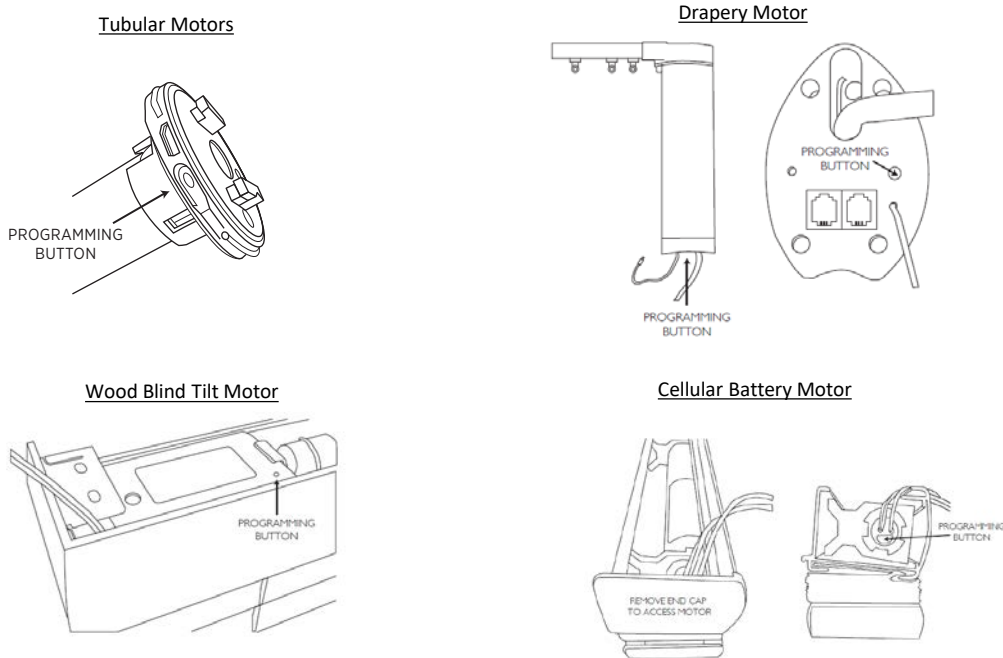



Note: Drapery motor will only beep.

The motor will jog 4 times before the reset is complete. The programming button must be held the entire time. 4 beeps confirm the factory reset is complete. *(\*\*External battery motors will jog 3 times for factory reset\*\*)*

**\*\*\*Refer to the Initial Setup Programming section to program a shade after a factory reset.\*\*\***

# Initial Setup Programming

## 1. SELECT CHANNEL

<p><b>1a</b></p> <p>Press any button to wake remote.</p>	<p><b>1b</b></p> <p>Within <b>10sec</b> Press <b>UP or DOWN</b> to select desired channel.</p>	 or 	<p><b>1c</b></p> <p>Press <b>STOP</b> to confirm selection OR remote will auto confirm after 4sec.</p>	
--	--	--	--	---

## 2. PAIRING REMOTE TO MOTOR

### 2a ACTIVATE PAIRING MODE ON MOTOR

**Press & HOLD Programming Button on motor head (2sec)**

**Motor Response**



Note: Drapery motor will only beep.

Tubular Motors

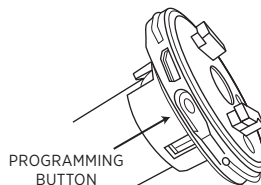

Drapery Motor

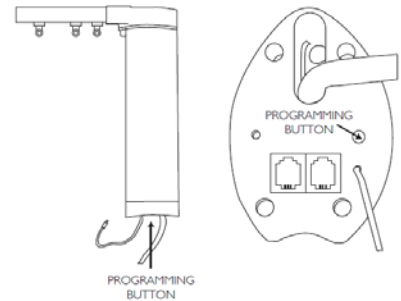

Cellular Battery Motor

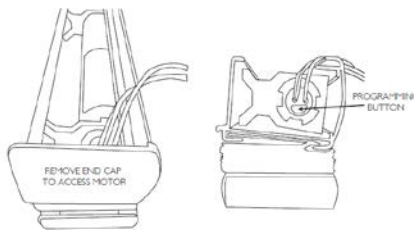

Wood Blind Tilt Motor

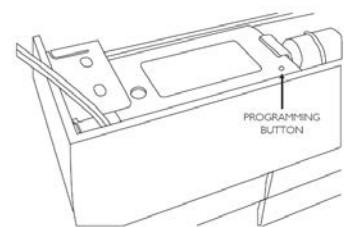

### 2b PAIRING REMOTE

**Within 4 sec of activating pairing mode, Press & Hold STOP**



**Motor Response**



Note: Drapery motor will only beep.

If you do not pair the remote in time the motor pairing sequence will time out, repeat the above steps assuring to press and hold the STOP button within 4 seconds of the motor jog



# Initial Setup Programming

## 3. Unlock/Lock Remote (Limit Setting Mode)

If limits need adjusting, follow the instructions below to unlock the remote for limit setting:

- Unlock the limit setting functionality by pressing the top right button on the back of the remote (remove cover to expose the button)
- Press and hold the button for approximately 8 seconds until the LED display shows a flashing "U", then release.
- PLEASE NOTE - You will need to "Lock" the remote once final adjustments have been made. Simply repeat the above step until a flashing "L" shows on the display ("U" for unlocked, "L" for locked).

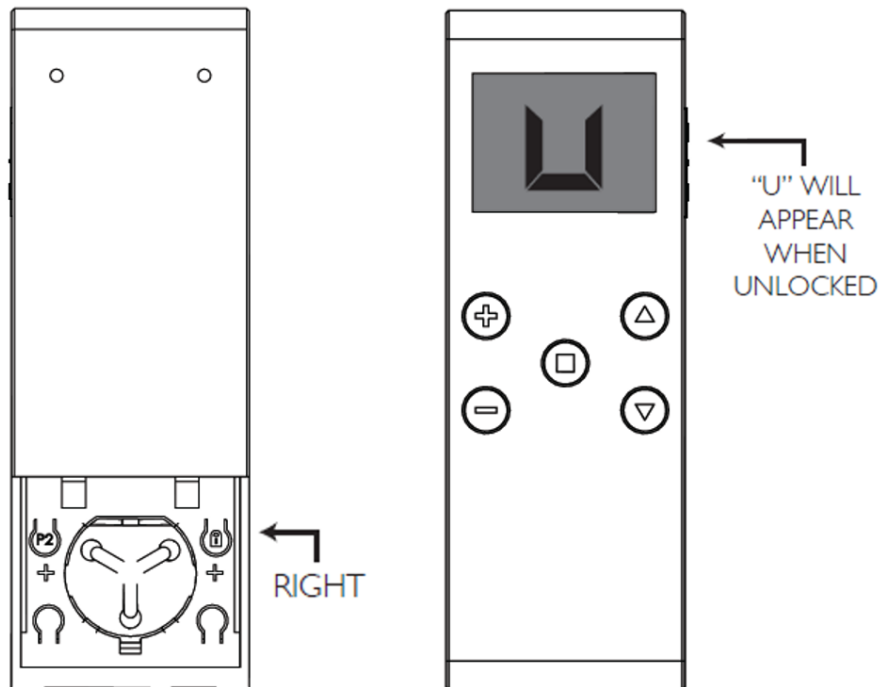

# Initial Setup Programming

## 4. Reverse Motor Direction If Required (Options A or B)

### Option A - REMOTE OPERATION

**(Reversing motor direction using this method is only possible during initial set-up, prior to first time limit setting, or after a re-set of motor)**

To check motor direction, quickly press the UP **or** DOWN button to move the shade initially. Press STOP to pause the shade operation.

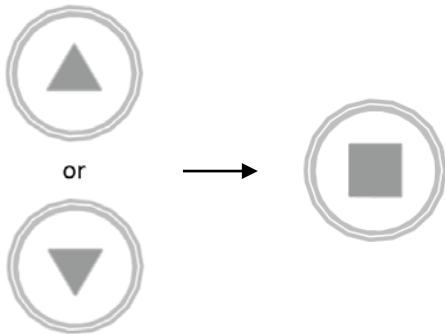

**Drapery** – For correct operation, **UP** should open Drapery and **DOWN** should close.

IF DIRECTION DOES NOT ALIGN WITH UP/DOWN BUTTONS – Press and hold down the UP **and** DOWN button simultaneously until the motor jogs UP and DOWN once.



Motor Response



Note: Drapery motor will not jog. Will beep 3 times to confirm.

### Option B - MOTOR OPERATION (Possible At Any Time)

Hold Programming Button (10 sec)



Note: Drapery motor will only beep.

Tubular Motors

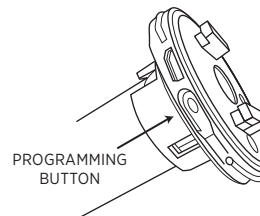

Drapery Motor

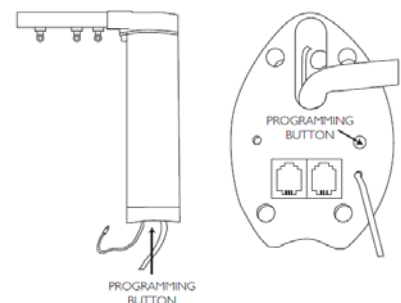

Wood Blind Tilt Motor

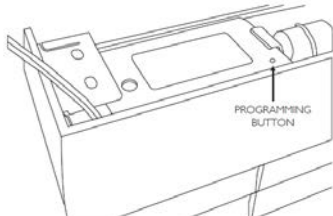

Cellular Battery Motor

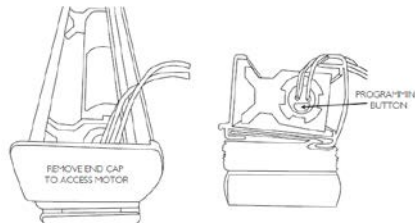

# Initial Setup Programming

## 5. Setting Limits

### ROLLER/SOLAR SHADE, ROMAN SHADES, WOVEN WOOD, CELLULAR, PLEATED, WOOD BLIND

**Important!!** When attempting below steps, be sure to stop the shade prior to traveling past the desired position or damage to product can occur.

Drive the shade using continuous movement or fine adjust to the position you wish to set as the upper limit. Set limit as described below. 3 beeps from the motor will confirm the limit is saved. Repeat the same process to drive to and set the lower limit.

#### (To SET Top Limit)

Press **UP + STOP (3sec)**

Motor Response

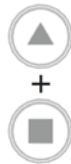

#### (To SET Bottom Limit)

Press **DOWN + STOP (3sec)**

Motor Response

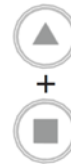

**!!WARNING!!** - Move shade in short increments by pressing the UP/DOWN button in 1 second intervals (pressing the UP/DOWN button for more than 3 seconds may send the shade past desired upper/lower limit and may result in damage to the product). Once you have reached the desired upper/lower limit, you can adjust the limit with either the UP and DOWN buttons. (remember to adjust in short increments!)

### DRAPERY

The Drapery Motor features automatic limit detection. Once the motor is attached to an installed track, limits can be set with a few simple actions.

Press the **UP** or **DOWN** buttons on controller. Carrier will run to the end of the track.

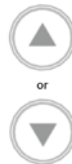

**Important!!** Remember to return the remote control to "L" mode as previously described to prevent inadvertent shade adjustment during normal operation and remote handling.

# Reverse Motor Direction

Each battery & plug-in motor will come preprogrammed from The Shade Store. The preprogramming ensures the remote is paired with the motor, the upper and lower operation limits are set, the remote is locked and the unnecessary channels are hidden for ease of use (15 available).

To reverse the motor direction at any time, use the motor operation method shown below.  
*(Applicable to internal tubular motors only, for external battery motors follow the below steps but only hold the programming button for 2 jogs)*

## MOTOR OPERATION (Possible At Any Time)

Tubular Motors

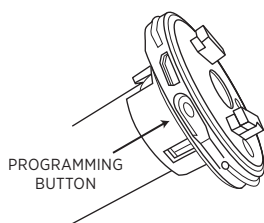

Drapery Motor

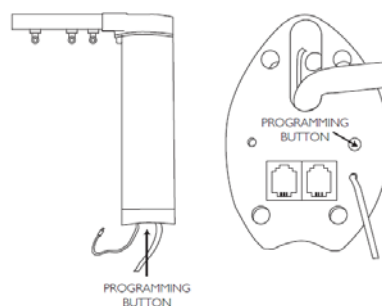

Wood Blind Tilt Motor

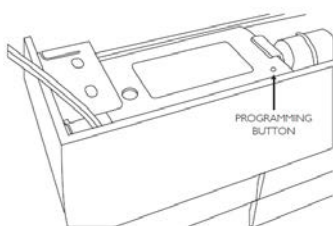

Cellular Battery Motor

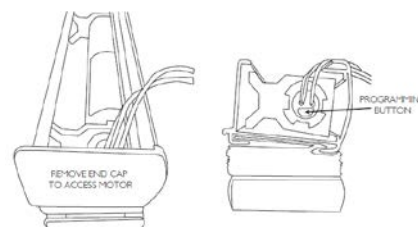

Hold Programming Button (10 sec)



Note: Drapery motor will only beep.

# Tilt Mode (Wood Blind Only)

Each battery & plug-in motor will come preprogrammed from the factory.

The preprogramming ensures the remote is paired with the motor, the upper and lower operation limits are set, the remote is locked and the unnecessary channels are hidden for ease of use (15 available).

Follow the below steps to switch between tilt mode (incremental movement) or roller mode (drives to limits) on any motor. The motor must be paired to a remote and the remote must be unlocked to execute this procedure. Motors come programmed by default in roller mode.

If limits need adjusting, follow the instructions below to unlock the remote for limit setting:

- Unlock the limit setting functionality by pressing the top right button on the back of the remote (remove cover to expose the button)
- Press and hold the button for approximately 8 seconds until the LED display shows a flashing "U", then release.
- PLEASE NOTE - You will need to "Lock" the remote once final adjustments have been made. Simply repeat the above step until a flashing "L" shows on the display ("U" for unlocked, "L" for locked).

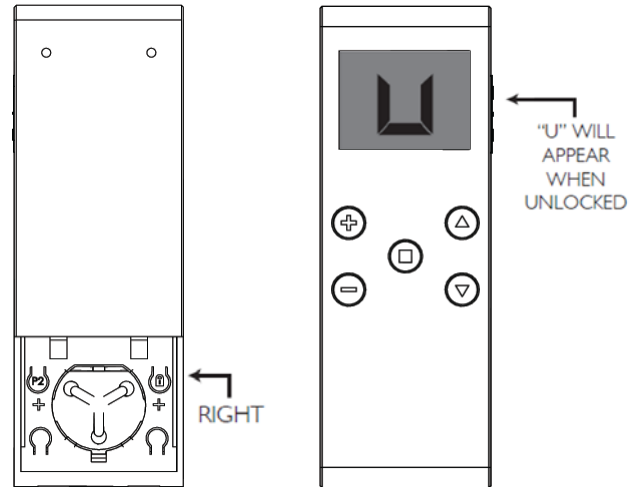

With the remote unlocked. Hold the UP and DOWN button on the controller for approximately 5 seconds. The motor will jog up and down once.

Immediately after the motor jogs, press and hold the STOP button. The motor will jog up and down and beep to confirm Tilt Mode has been entered.

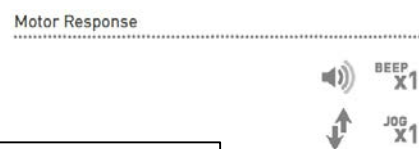

Repeat the above procedure to re-enter Roller Mode

If you do not activate tilt mode in time the motor programming sequence will time out, repeat the above steps assuring to press the STOP button within 4 seconds of the motor jog

# Troubleshooting

---

PROBLEM	CAUSE	REMEDY
Motor is not responding	Remote battery has been completely discharged	Replace battery with new 3V - CR2450 Battery
	Battery is inserted incorrectly	Check battery positioning
	Radio interference / Shielding	Ensure remote is positioned away from metal objects and that antenna on motor or receiver is kept straight and away from metal.
	Receiver distance is too far from remote	Move remote to a closer position.
	Power failure	Check power supply to motor is connected and active.
Cannot adjust limits on a single motor (multiple motors respond)	Multiple motors are grouped onto one channel.	Disconnect power to other motors or put them in sleep mode.