

INSTALLING YOUR MOTORIZED ROLLER & SOLAR SHADES

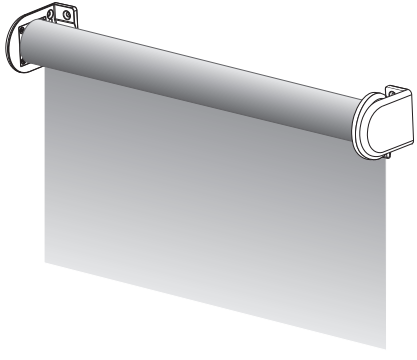

PARTS INCLUDED:

- 4x Screws (per shade)
- 2x Mounting Brackets (per shade)
- 1x Plug-In Charger w/Extension Cable*
- 1x Motor Cap Cover
- Remote Control(s)

*Battery Motor Only

TOOLS YOU WILL NEED:

- Drill with a 1/8" bit & a Phillips bit
- Phillips Screwdriver
- Metal Tape Measure

MOUNT TYPE YOUR INSTALLING FOR:

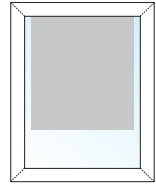

FOR INSIDE MOUNT
SEE SECTION 1A

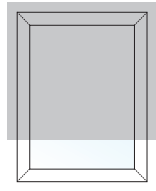

FOR OUTSIDE MOUNT
SEE SECTION 1B

Note: Your brackets must be securely attached to the mounting surface. If your screws are not secure you'll have to use a different fastener which can be found at any local hardware store.

1A. Mounting Your Brackets - Inside Mount

- Attach the brackets with two screws to the window frame, window molding, wall, or ceiling, as shown.
- Brackets are universal so they may be mounted on either side.
- There are few easy ways to install your brackets - choose which is best suited for your situation.

INSTALL BRACKETS UPWARD

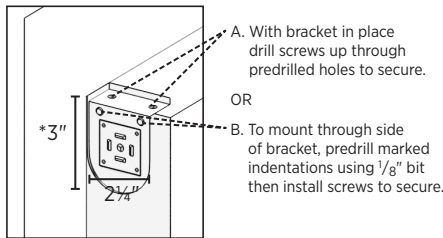

INSTALL BRACKETS STRAIGHT ON

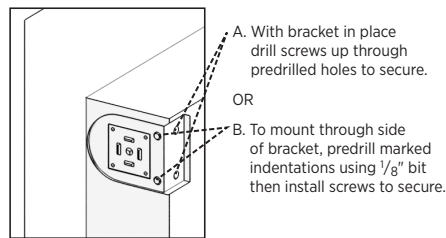

SHALLOW DEPTH BRACKET INSTALLATION

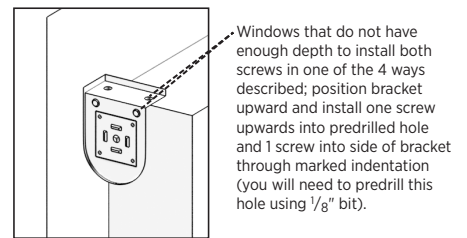

Note: For thicker fabrics, wider widths, or longer lengths, you may be provided with an extension bracket to accommodate a larger shade diameter. In this case, the measurement from the base of the bracket to the pinnacle of the bracket's curve would be 3 3/4".

1B. Mounting Your Brackets - Outside Mount

- Fit the shade into both brackets and center the shade over the window (this may take two people).
- With a pencil, mark the wall on the side of one bracket, remove the shade and attach the bracket with two screws.
- Insert the shade into the next bracket, hold the shade up and insert the other end into the already mounted bracket (make sure shade is level).
- Mark the wall on the side of the second bracket, remove shade, and attach the second bracket with two screws.

OUTSIDE WINDOW CASING/FRAME MOUNT

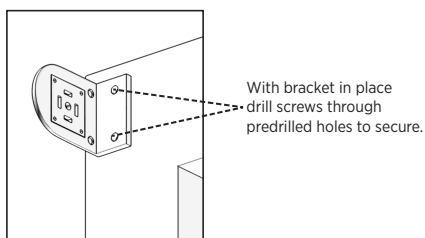

OUTSIDE MOUNT

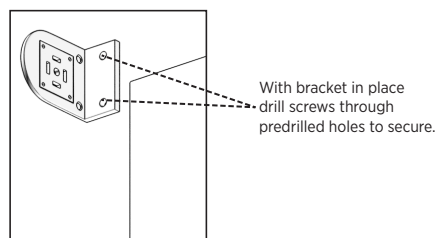

CEILING MOUNT

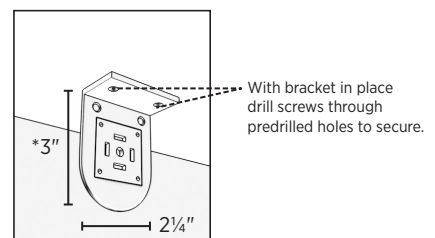

Note: For thicker fabrics, wider widths, or longer lengths, you may be provided with an extension bracket to accommodate a larger shade diameter. In this case, the measurement from the base of the bracket to the pinnacle of the bracket's curve would be 3 3/4".

2. Installing Your Shade

- With the brackets now installed, you may install your shade. Put the spring loaded pin end into the round hole of the bracket.
- Pushing the pin end towards its bracket, insert the hooks on the motor side straight into the two slots in the bracket [FIG 1].
- Once the two hooks are through the slots, gently pull down on the motor side until the two hooks have locked securely to the bracket (make sure hooks are facing down) [FIG 2].

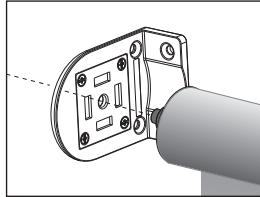

FIGURE 1 - Insert pin end

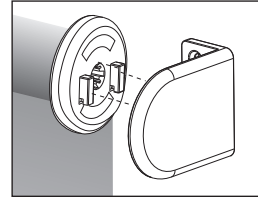
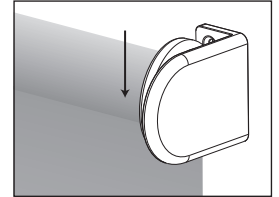

FIGURE 2 - Insert hooks and pull down



3. Powering on Your Shade

To Activate (Wake Up) Your Battery Motor

- If you selected a battery motor, it's fully charged and has been put into "Sleep Mode" to avoid operation during shipping.
- Press and hold the programming button on the motor head until the motor jogs up and down once.
- The shade is now no longer in "Sleep Mode" and ready for use.
- **Warning: if you press and release the programming button quickly, the motor will lower to its lower limit. Be mindful of this during install process.*

To Activate the Plug-In Motor

- Plug your motor into the wall outlet that will power the shade.
- The shade is ready to use.

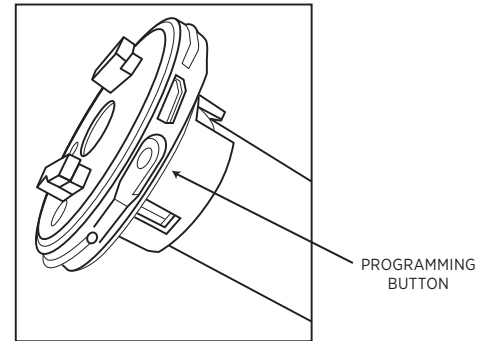

4. Installing the Cap Cover

- Snap the cover over motor head and wires with the flat part of the cap towards the mounting bracket.
- Rotate clockwise or counter clockwise around the motor head to best hide antenna and power cord as needed.

Note: For extended remote range you can leave the antenna exposed.

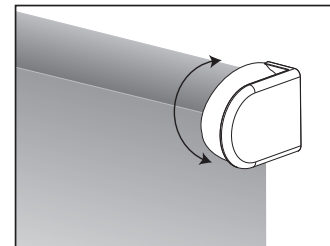
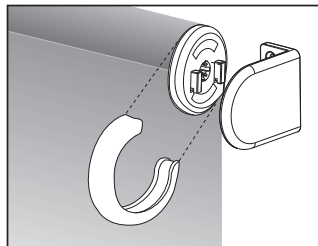

5. Operating Your Shade

- Your shades have been pre-programmed.
- A channel has been assigned to each motor based on your specifications.
- We've also set approximate upper and lower limits.
- For more information, see the Quick Start Guide that came with your shade or visit www.theshadestore.com/motors-help.

Care and Cleaning

Always clean with a low suction, hand held vacuum or dust with a soft, clean cloth or feather duster. If you're dealing with dirt and stains, we suggest using a Mr. Clean® magic eraser to spot treat dirt and stains. This is available online, at local home improvement stores or we can send directly to you via USPS (1-3 days) at no charge.

Warranty

The Shade Store products are covered by a limited lifetime warranty. This warranty covers any defects in materials or workmanship so long as the product is measured and installed according to instructions. Every Shade Store window treatment is designed to provide trouble-free use.

INSTALLING YOUR MOTORIZED ROLLER & SOLAR SHADES WITH METAL VALANCE

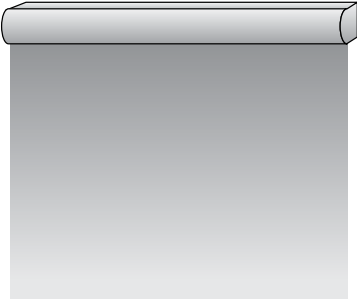

PARTS INCLUDED:

- 4x Screws (per shade)
- 2x Mounting Brackets
- 1x Plug-In Charger w/Extension Cable*
- Remote Control(s)

*Battery Motor Only

Note: Your brackets must be securely attached to the mounting surface. If your screws are not secure you'll have to use a different fastener which can be found at any local hardware store.

TOOLS YOU WILL NEED:

- Drill with a 1/8" bit & a Phillips bit
- Phillips Screwdriver
- Metal Tape Measure

MOUNT TYPE YOUR INSTALLING FOR:

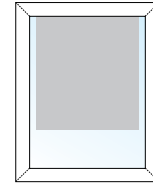

FOR INSIDE MOUNT
SEE SECTION 1A

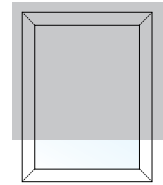

FOR OUTSIDE MOUNT
SEE SECTION 1B

1A. Mounting Your Shade - Inside Mount

- For inside or ceiling mounts, use the top bracket holes
- Make sure the release tab is always mounted on the bottom
- Mount the brackets to the wall or window frame, with the outside brackets no further than 2 inches (5 cm) from the ends of the valance. On wide shades, space the additional bracket(s) at equal intervals.

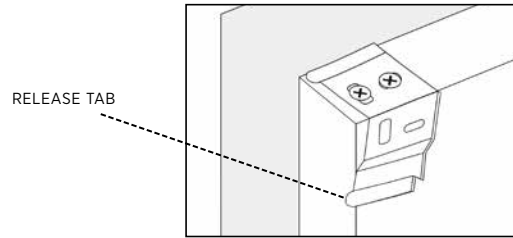

1B. Mounting Your Shade - Outside Mount

- For wall or outside mounts, use the rear bracket holes
- Make sure the release tab is always mounted on the bottom
- Mount the brackets to the wall or window frame, with the outside brackets no further than 2 inches (5 cm) from the ends of the valance. On wide shades, space the additional bracket(s) at equal intervals.

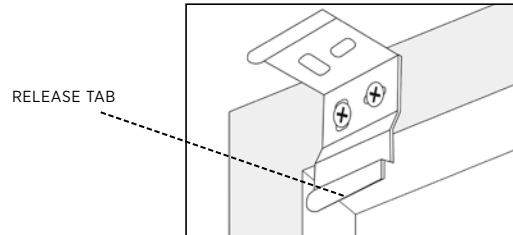

2. Mounting the Valance

- Position the valance with the front panel (A) resting on the top lip of all brackets.
- Push the bottom front of the valance firmly backwards and toward the window until the lip on the rear of the valances engages the bracket and snaps into place, (B) as shown.

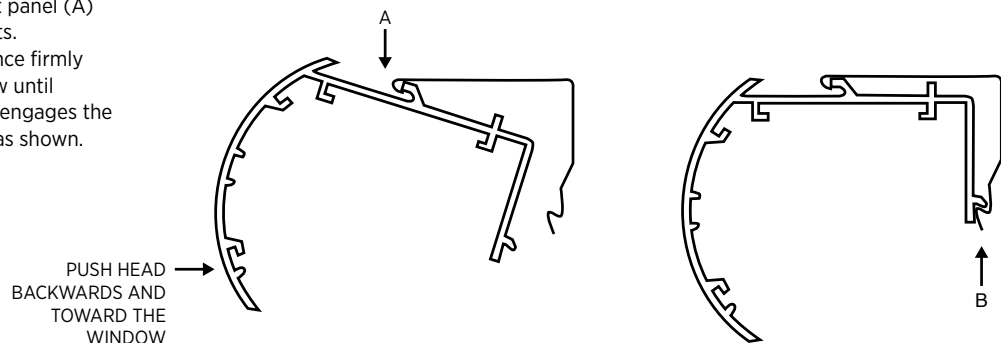

3. Powering on Your Shade

To Activate (Wake) Your Battery Motor

- If you selected a battery motor, it's fully charged and has been put into "Sleep Mode" to avoid operation during shipping.
- Press and hold the programming button on the motor head until the motor jogs up and down once.
- The shade is now no longer in "Sleep Mode" and ready for use.
- **Warning: if you press and release the programming button quickly, the motor will lower to its lower limit. Be mindful of this during install process.*

To Activate the Plug-In Motor

- Plug your motor into the wall outlet that will power the shade.
- The shade is ready to use.

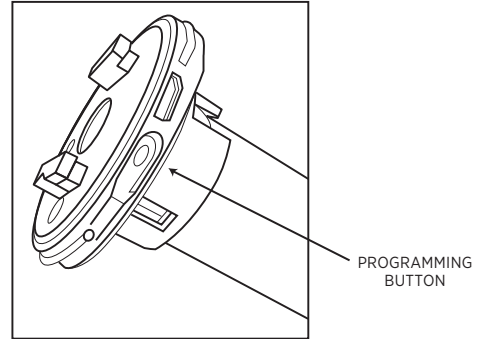

4. Operating Your Shade

- Your shades have been pre-programmed.
- A channel has been assigned to each motor based on your specifications.
- We've also set approximate upper and lower limits.
- For more information, see the Quick Start Guide that came with your shade or visit www.theshadestore.com/motors-help.

Care and Cleaning

Always clean with a low suction, hand held vacuum or dust with a soft, clean cloth or feather duster. If you're dealing with dirt and stains, we suggest using a Mr. Clean® magic eraser to spot treat dirt and stains. This is available online, at local home improvement stores or we can send directly to you via USPS (1-3 days) at no charge.

Warranty

The Shade Store products are covered by a limited lifetime warranty. This warranty covers any defects in materials or workmanship so long as the product is measured and installed according to instructions. Every Shade Store window treatment is designed to provide trouble-free use.