

INSTALLING YOUR MOTORIZED WOOD BLINDS

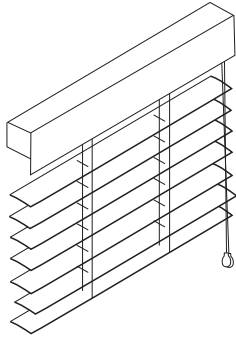

PARTS INCLUDED:

- Screws
- 2x Mounting Brackets
- Valance
- Cord Cleat
- 1x Plug-In Charger w/Extension Cable
- Battery Wand with Brackets
- Remote Control(s)

TOOLS YOU WILL NEED:

- Drill with a 1/8" bit & a Phillips bit
- Phillips Screwdriver
- Metal Tape Measure

MOUNT TYPE YOUR INSTALLING FOR:

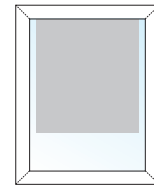

FOR INSIDE MOUNT
SEE SECTION 1A

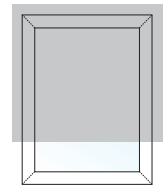

FOR OUTSIDE MOUNT
SEE SECTION 1B

Note: Your brackets must be securely attached to the mounting surface. If your screws are not you'll have to use a different fastener which can be found at any local hardware store.

1A. Mounting Your Brackets - Inside Mount

Hold the blind against the window to determine the proper placement. It will either fit inside the window casing (inside mount) or outside on the window casing or wall (outside mount). This will determine where and how your installation brackets should be attached.

Inside Mount

- Make certain the headrail is level and clear of obstructions.
- Make pencil marks 1/8" below the headrail on each end.
- The bottom of the installation brackets will be placed on these marks.

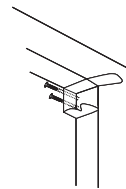

INSIDE MOUNT

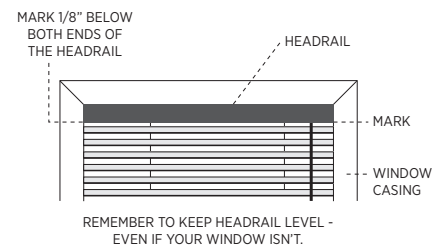

1B. Mounting Your Brackets - Outside Mount

Hold the blind against the window to determine the proper placement. It will either fit inside the window casing (inside mount) or outside on the window casing or wall (outside mount). This will determine where and how your installation brackets should be attached.

Outside Mount

- Hold the blind level and center against the window casing or wall.
- Mark the casing/wall with a pencil just below the headrail on each end.
- Also mark the window casing/wall 1/8" beyond the ends of the headrail. The installation brackets will be placed on these marks.

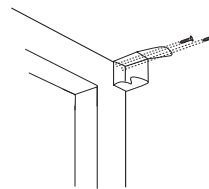

OUTSIDE MOUNT

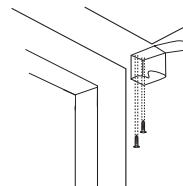

OVERHEAD OUTSIDE MOUNT

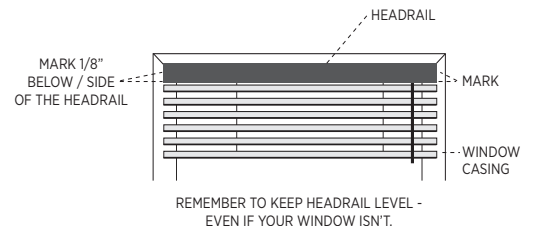

Note: If you are installing an external battery motor, you'll need an extra 1 1/2" clearance. See Step 4 for battery mounting options.

1C. Mounting Your Brackets - Auxiliary Support Brackets (Optional)

If an auxiliary support bracket is included with your blind it should be placed in line with the installation brackets. The auxiliary support should not be in line vertically with the blind's cord or ladder as it may interfere with the blind's lifting and tilting mechanism.

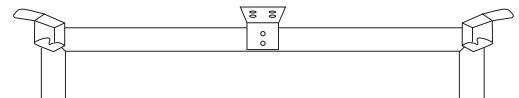

2. Installing Your Headrail

- With brackets installed insert the headrail into the mounting brackets.
- If your blind is not fitting snugly left to right, open the mounting brackets, remove the headrail and pry out the tab at the end of the headrail with a screwdriver.

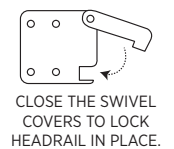
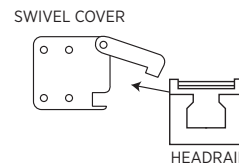
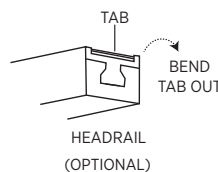
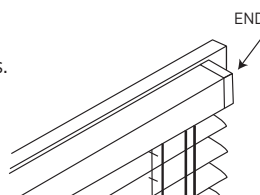

3. Battery Wand and Motor

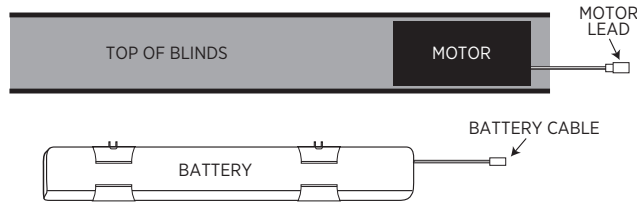

4. Installing the Battery Wand

For Option 1 (Inside Mount Only)

- Mount battery to back of blinds.
- Connect battery cable to motor lead.

For Option 2 & 3

- Select the desired location for your Battery Wand and mark location.
- Install the Battery Clips at marked location, 6" from each other, on center, with the included screws. Be sure that the Clips are level with each other.
- Gently slide Battery Wand into clips.
- Connect battery cable to motor lead.

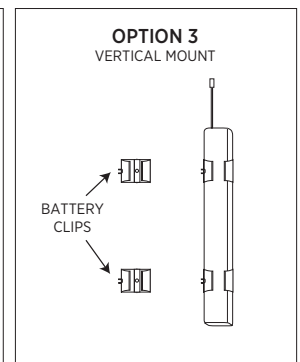
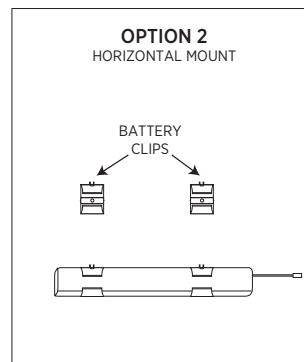
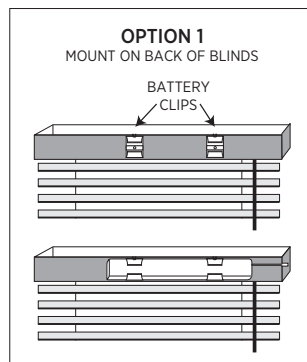

Note: Distance from motor lead to battery not to exceed 18".
For longer leads please contact help@theshadestore.com.

5. Attaching Your Valance

- Magnets come screwed into the valance; simply stick the magnetic valance to the headrail.
- If your blind was ordered as an outside mount, the valance is supplied with pre-mounted returns.
- No returns are included with an inside mount.

6. Attaching Your Cord Cleat

- To prevent dangling cords which may be hazardous to small children and pets, mount the cord cleat to the wall or window frame next to your blinds.
- Using the screws provided, mount the cord cleat at a safe height, taking into account furniture or other objects upon which a child may climb.
- After each use of the shade, simply wrap the excess cord around the cleat. It's fast, easy and safe.



7. Operating Your Blinds

- Your blinds have been pre-programmed - remember the motor controls the tilt only.
- To raise the blinds, pull the cord downward. To lower the blinds, pull the cord down and toward the center.
- A channel has been assigned to each motor based on your specifications.
- For more information, see the Quick Start Guide that came with your blinds or visit www.theshadestore.com/motors-help.

Care and Cleaning

General Dusting: We recommend using a dry cloth or vacuum with soft attachment to remove surface dust.

Dealing with Dirt: Most dirt can be removed easily by simply using a damp cloth. A mild mixture of soap and water can also be used as necessary.

Warranty

The Shade Store products are covered by a limited lifetime warranty. This warranty covers any defects in materials or workmanship so long as the product is measured and installed according to instructions. Every Shade Store window treatment is designed to provide trouble-free use.